

ATTIX 550-01
ATTIX 550-11 MOBIL
ATTIX 550-21
ATTIX 590-21
ATTIX 12 GALLON
ATTIX 12 GALLON RDF
ATTIX EC 12 GALLON AS/E



Nilfisk
ALTO

Why Compromise

DE	Bedienungsanleitung	3
EN	Operating Instructions	14
FR	Notice d'utilisation	25
NL	Gebruiksaanwijzing	36
IT	Istruzioni sull'uso	47
NO	Driftsinstruks	58
SV	Bruksanvisning	69
DA	Driftsvejledning	80
FI	Käyttöohje	91
SL	Navodilo za uporabo	102
HR	Uputstvo za rad	113
SK	Prevádzkový návod	124
CS	Provozní návod	135
PL	Instrukcja obsługi	146
HU	Kezelési utasítás	157
ES	Instrucciones de manejo	168
PT	Instruções de operação	179
EL	Οδηγίες λειτουργίας	190
TR	Yönetme kılavuzu	201
RU	Руководство по эксплуатации	212

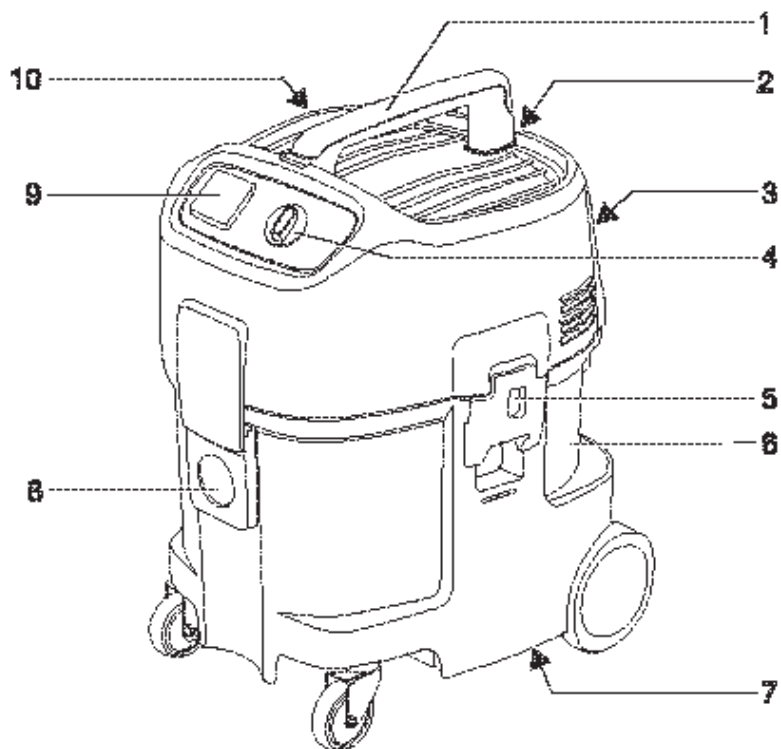



Contents

Symbols used to mark instructions	15
1 Important safety instructions	15
2 Description	2.1 Purpose.....	17
	2.2 Operating elements.....	17
3 Before starting	3.1 Assembling the vacuum cleaner.....	17
4 Operation	4.1 Connections.....	18
	4.1.1 Connecting the suction hose.....	18
	4.1.2 Electrical connection.....	18
	4.1.3 Connecting power tools ¹⁾	18
	4.2 Switching on the vacuum cleaner.....	18
	4.2.1 Switch position "I".....	18
	4.2.2 Switch position "auto" ¹⁾	18
	4.2.3 Suction power control ¹⁾	19
5 Applications and techniques	5.1 Techniques.....	19
	5.1.1 Picking up dry substances.....	19
	5.1.2 Picking up liquids.....	19
6 After finishing work	6.1 Switching the vacuum cleaner off and storage.....	20
7 Maintenance	7.1 Maintenance plan.....	20
	7.2 Maintenance work.....	21
	7.2.1 Emptying the dirt tank.....	21
	7.2.2 Replacing the filter bag.....	21
	7.2.3 Replacing the filter element.....	21
8 Troubleshooting	22
9 Further information	9.1 Recycling the vacuum cleaner.....	23
	9.2 Guarantee.....	23
	9.3 Tests and approvals.....	24
	9.4 Technical data.....	24
	9.5 Accessories.....	24
	9.6 EC declaration of conformity.....	24

Symbols used to mark instructions



Safety instructions marked with this symbol must be observed to prevent danger to persons.



This symbol is used to mark safety instructions that must be observed to prevent damage to the vacuum cleaner and its performance.



This indicates tips and instructions to simplify work and to ensure safe operation.

1 Important safety instructions

For your own safety



Before using the vacuum cleaner, always read the operating instructions and keep them readily available.

Only allow the vacuum cleaner to be used by persons who have been trained in its use and who have been explicitly authorized to use it.

General

The use of the vacuum cleaner is subject to valid national regulations.

The vacuum cleaner is suitable for commercial use, e.g. in hotels, schools, hospitals, factories, shops, offices and rental businesses.

Besides the operating instructions and the binding accident prevention regulations valid in the country of use, observe recognized regulations for safety and proper use.

Do not use any unsafe work techniques.

Hazardous dust

This vacuum cleaner is not suitable for removing hazardous dust.

Risk of fire and explosion



The following materials should not be sucked into the vacuum cleaner:

- hot materials (burning cigarettes, hot ashes, etc.)
- flammable, explosive, aggressive liquids (e.g. petrol, solvents, acids, alkalis, etc.)
- flammable, explosive dusts (e.g. magnesium or aluminium dust, etc.)

¹⁾ Option depending on model

EN **Appliance socket**

Use the socket on the vacuum cleaner for the purpose defined in the operating instructions only.

Before plugging an appliance into the appliance socket:

1. Switch off the vacuum cleaner
2. Switch off the appliance to be connected.

CAUTION!

Follow the operating instructions and safety instructions for appliances connected to the appliance socket.

Transport

After sucking up water, do not tilt the cleaner or transport it in a horizontal position.

Before starting the vacuum cleaner

Before starting the vacuum cleaner, check that it is in proper condition. Plugs and couplings in power cords must at least have splash protection.

Regularly check whether the power cord is damaged or shows signs of aging. Before using the cleaner, ensure that the cover and power cord are intact. (There is risk of electrocution if they are damaged.)

Never use the vacuum cleaner if the filter element is damaged.

During use

Do not damage the power cord (e.g. by moving over it or pulling or squeezing it).

Disconnect the power cord by pulling the plug only (do not pull or tug the power cord).

CAUTION!

Before sucking in liquids, remove the filter bag and check the performance of the floater (see section 7.2.3).

If foam appears, stop work immediately and empty the tank.

Maintenance and repair

CAUTION!

Always pull out the mains plug before cleaning and servicing the vacuum cleaner.

Only carry out maintenance work described in the operating instructions.

CAUTION!

Use original Alto accessories and parts only. The use of other parts can adversely affect safety.

CAUTION!

Do not make technical modifications to the vacuum cleaner. They could endanger your safety.

For further maintenance or repair work and the replacement of a faulty power cord please contact the Alto service department or an authorized Alto workshop.

Electrical connections



Check the rated voltage of the vacuum cleaner before connecting it to the mains supply system. Ensure that the voltage shown on the rating plate corresponds to the voltage of the local mains power supply.

If you are using an extension cord, use only those specified

by the manufacturer or higher quality ones (see section 9.4 "Technical data").

It is recommended that the vacuum cleaner is connected via a residual current circuit breaker. This device stops the supply of electricity if the leakage current to earth exceeds 30 mA for 30 ms or it has an earth tester circuit.

When using an extension cord, check the minimum cross-sections of the cable:

Cable length m	Cross section mm ²
up to 20	1.5
20 to 50	2.5

Arrange the electrical parts (sockets, plugs and couplings) and lay down the extension cord so that protection class is maintained.

CAUTION!

Never spray water on to the upper section of the vacuum cleaner: danger for persons, risk of short-circuiting.

Observe the latest edition of the IEC regulations.

2 Description

- 2.1 Purpose** When used properly, the industrial vacuum cleaners described in these instructions are suitable for sucking up dry, non-flammable dusts and liquids.
- 2.2 Operating elements** See fold-out page at front of these operating instructions.
- | | |
|---|----------------------------------|
| 1 Handle | 5 Retaining clamp |
| 2 Suction tube fastener | 6 Dirt tank |
| 3 Mounting for accessories | 7 Grip to empty tank |
| 4 Appliance switch with suction power control ¹⁾ | 8 Inlet fitting |
| | 9 Appliance socket ¹⁾ |
| | 10 Cable hook |

3 Before starting

3.1 Assembling the vacuum cleaner

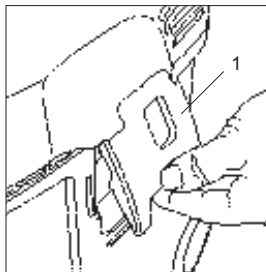

1. The mains plug should not yet be inserted into a socket.
2. Open the retaining clamps (1) and remove upper section of the cleaner.
3. Take the accessories¹⁾ out of the dirt tank and the packaging.
4. Place a filter bag into the tank as described in the instructions (printed on the filter bag).

IMPORTANT!

Press the filter bag connection firmly on to the inlet fitting.

5. Fit the upper section of the cleaner (do not damage the filter bag) and close the retaining clamps.

NOTE!

Ensure that the retaining clamps fit properly.

¹⁾ Option depending on model

4 Operation

4.1 Connections

4.1.1 Connecting the suction hose

1. Connect the suction hose.

4.1.2 Electrical connection

The operating voltage shown on the rating plate must correspond to the voltage of the mains power supply.

1. **Ensure that the cleaner is switched off.**
2. Insert the power cord into a properly installed and fused socket with earthing contact.

4.1.3 Connecting power tools¹⁾

To comply with regulations, only approved dust producing tools should be connected.

The maximum power consumption of the connected power tool is stated in section 9.4 "Technical data".

1. **Ensure that the power tool is switched off.**
2. Connect the power tool to the appliance socket¹⁾ on the control panel.

4.2 Switching on the vacuum cleaner

4.2.1 Switch position "I"

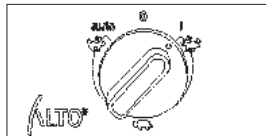

1. Turn the switch to position "I".
The vacuum cleaner motor starts.

4.2.2 Switch position "auto"¹⁾

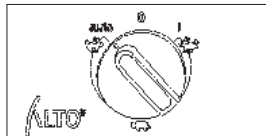

CAUTION!
Before switching the switch to position "auto", ensure that the power tool connected to the appliance socket is switched off.

1. Turn the switch to position "auto"¹⁾.
The vacuum cleaner motor starts when the connected power tool is switched on.
2. When the power tool is switched off, the vacuum cleaner continues to run for a short moment so that any dust in the suction hose is conveyed to the filter bag.

4.2.3 Suction power control¹⁾

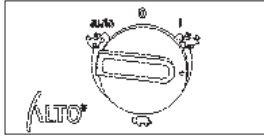

The motor speed and the suction power can be varied with the suction power control¹⁾. This allows precise adaptation of the suction power for different cleaning tasks.



5 Applications and techniques

5.1 Techniques

If used correctly, additional accessories, suction nozzles and suction hoses can enhance the cleaning action and reduce the cleaning effort. Effective cleaning is achieved if you follow just a few guidelines

in combination with your own practical experience in special fields.

Here are some basic tips.

5.1.1 Picking up dry substances



CAUTION!
Do not pick up flammable substances.

Before picking up dry substances, always ensure that a filter bag is inserted in the tank (see section 9.5 "Accessories" for order number). Disposal of the picked up material is then simple and hygienic.

element is wet. A damp filter element clogs more quickly when dry substances are picked up. For this reason the filter element should be washed and dried or replaced by a dry element before dry substances are picked up.

5.1.2 Picking up liquids



After picking up liquids, the filter

CAUTION!
Do not pick up flammable liquids.

Always remove the filter bag and check the floater before picking up liquids (see section 7.2.3 "Replacing the filter element"). The use of a separate filter element or filter screen is recommended.

If foam appears, stop work immediately and empty the tank.

To reduce the amount of foam, use foam killer Alto Foam Stop (see section 9.5 "Accessories" for order number).

¹⁾ Option depending on model



6 After finishing work

6.1 Switching the vacuum cleaner off and storage

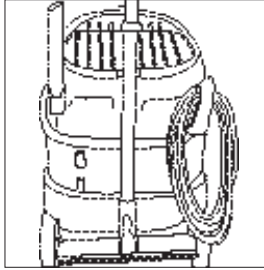

1. Switch off the vacuum cleaner and pull the mains plug out of the socket.
2. Wind up the power cord and hang it on the handle.
3. Empty the tank and clean the vacuum cleaner.
4. After picking up liquids: Store the upper section of the cleaner separately so that the filter element can dry.
5. Store the cleaner in a dry room where it is protected from unauthorized use.

7 Maintenance

7.1 Maintenance plan

	After work	As required
7.2.1 Emptying the dirt tank		●
7.2.2 Replacing the filter bag		●
7.2.3 Replacing the filter element		●
7.2.4 Check suction hose and accessories for clogging, clean if necessary	●	

7.2 Maintenance work

7.2.1 Emptying the dirt tank

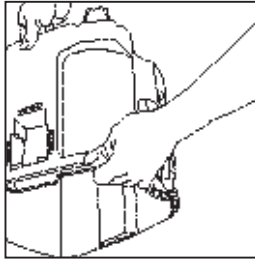

Empty the dirt tank when vacuuming without a filter bag.



1. Remove the upper section of the cleaner from the dirt tank.
2. Hold the dirt tank at the grip underneath the tank and tip out the dirt.
3. Dispose of the dirt in accordance with legal regulations.
4. Clean the rim of the tank before fitting the upper section of cleaner.

Before reinserting the suction hose:

5. Clean the inlet fitting and hose collar.

7.2.2 Replacing the filter bag

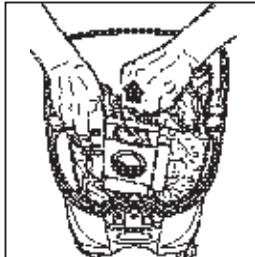

1. Remove the upper section of cleaner from the dirt tank.
2. Carefully remove the filter bag connection from the inlet fitting.
3. Close the filter bag connection with the slide.
4. Dispose of the filter bag in accordance with legal regulations.
5. Place a new filter bag into the clean tank as described in the instructions (printed on the filter bag).

IMPORTANT!

Press the filter bag connection firmly on to the inlet fitting.

7.2.3 Replacing the filter element

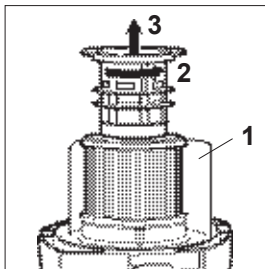

1. Remove the upper section of the cleaner from the dirt tank and deposit with the filter element facing upwards. Do not place the upper section of the cleaner on the guard (1).
2. Turn the filter holder anticlockwise (2) and remove it (3).
3. Carefully remove the filter element.
4. Clean the filter seal (4).

¹⁾ Option depending on model

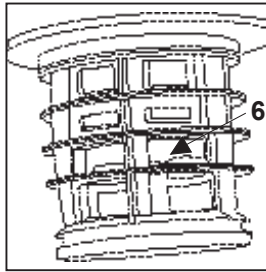
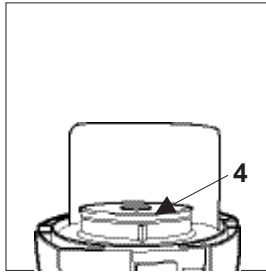
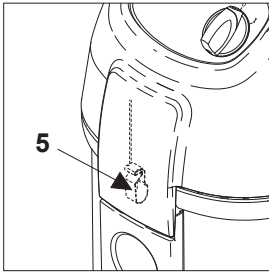

5. Check antistatic clamp (5) for damage and have it replaced by Alto Service if necessary.
6. Check the floater (6) for proper operation: When you turn the filter holder, the floater should move back and forth easily.
7. Fit a new filter element.
8. Fit the filter holder and turn it clockwise to secure it.
9. Dispose of the used filter element in accordance with legal regulations.

CAUTION!
 Never use the vacuum cleaner without a filter.

8 Troubleshooting

Fault	Cause	Remedy
‡ Motor does not start ‡ Power tool is defective or	> Fuse in mains plug has blown. > Overload protection switch has tripped. > Self-acting carbon brush is worn ¹⁾ not connected properly. > The power rating of the electrical tool is too low. • Check that the power tool	• Reset the fuse. • Switch off the vacuum cleaner and allow it to cool for approx. 5 minutes. If it can not be started again, contact the Alto service department. • Have carbon brushes changed by Alto Service. ‡ Motor does not run in auto- works or that the plug is inserted correctly. • Note that minimum power rating is P>40W



Fault	Cause	Remedy
‡ Reduced suction power	<ul style="list-style-type: none"> > Suction power selected with suction power control¹⁾ is too low. > Clogged suction hose/nozzle. > Seal/tank rim between the upper section of the cleaner and the dirt tank is dirty/defective. > Filter bag is full. > Filter element is clogged. 	<ul style="list-style-type: none"> ▪ Set suction power in accordance with section 4.2.3. "Suction power control". ▪ Clean suction hose/nozzle. ▪ Clean/replace seal. ▪ See section 7.2.2 "Replacing the filter bag". ▪ See section 4.3 "Cleaning the filter element" and 7.2.3 "Replacing the filter element".
‡ No suction power during wet cleaning	<ul style="list-style-type: none"> > Tank is full (floaters close the suction opening). 	<ul style="list-style-type: none"> ▪ Switch off the cleaner. Empty the tank.
‡ Voltage fluctuations	<ul style="list-style-type: none"> > Impedance of power supply is too high. 	<ul style="list-style-type: none"> ▪ Use a suitable extension cord (see section 9.4 "Technical data"). ▪ Connect the cleaner to another socket closer to the fuse box. Voltage fluctuations over 7 % should not occur if the impedance at the transfer point is $\leq 0.15 \Omega$.

9 Further information

9.1 Recycling the vacuum cleaner



Make the old cleaner unusable immediately.

1. Unplug the cleaner and cut the power cord.

The cleaner contains valuable materials that should be recycled. Therefore, make use of your local waste disposal site.

Contact your local authorities or your nearest dealer for further information.

9.2 Guarantee

Our general conditions of business are applicable with regard to the guarantee. Subject to change as a result of technical advances.

¹⁾ Option depending on model



9.3 Tests and approvals

Electrical tests must be performed in accordance with the provisions of safety regulations (VBG4) and to DIN VDE 0701 Part 1 and Part 3. In accordance with DIN VDE 0702 these tests must be performed

at regular intervals and after repairs or modifications.

The vacuum cleaner has been approved in accordance with IEC/EN 60335-2-69.

9.4 Technical data

		EU	CH, DK	GB 230/240V	GB 110V	ATTIX 12 GALLON	ATTIX 12 GALLON RDF ATTIX EC 12 GALLON AS/E
Voltage	Volt	230	230	230/240	110	120	120
Mains frequency	Hz	50/60	50/60	50/60	50/60	60	60
Power consumption	Watt	1200	1200	1200	1200	1000	840
Connected load for appliance socket ¹⁾	Watt	2400	1100	1800	560	-	600
Total connected load/fuse	Watt/A	3600/16	2300/10	3000/13	1760/16	1000/15	1440/15
		ATTIX 550-01 ATTIX 550-11 MOBIL ATTIX 550-21 ATTIX 590-21		ATTIX 12 GALLON	ATTIX 12 GALLON RDF ATTIX EC 12 GALLON AS/E		
Volume flow (air)	max. l/min.	3600		3600		3600	
Vacuum	max. Pa	23000		23000		23000	
Measuring surface sound pressure level measured at a distance of 1 m, ISO 3744	dB(A)	60		60		60	
Operating noise	dB(A)	57		57		57	
Power cord length	m	7,5 / 10,0(GB)		7,5		7,5	
Power cord type		H05RR-F 3 x 0,75		SJTW-A AWG 18/3		SJTW-A AWG 14/3	
Protection class		I		I		I	
Type of protection (splash water protected)		IP X4		IP X4		IP X4	
Radio interference suppression level		EN 50014-1		EN 50014-1		EN 50014-1	
Tank volume	l	45		45		45	
Width	mm	476		476		476	
Depth	mm	506		506		506	
Height	mm	655		655		655	
Weight	kg	14		14		14	

9.5 Accessories

Name	Order No.
Filter bags (pack of 5)	302 000 527
Filter element	302 000 490
Alto Foam STOP (6 x 1l)	8469

EU Declaration of Conformity

ALTO Deutschland GmbH
 Guido-Oberdorfer-Straße 2-8
 D-89287 Bellenberg

Product: Vacuum for wet and dry operation

Type: ATTIX 550-01/550-11 MOBIL/550-21/590-21
 ATTIX 12 GALLON / ATTIX 12 GALLON RDF
 ATTIX EC 12 GALLON AS/E

Description: 110/230-240 V~, 50/60 Hz

The design of the appliance corresponds to the following pertinent regulations:

EC Machine Directive	98/37/EG
EC Low-voltage Directive	73/23/EG
EC EMV Directive	89/336/EG

Applied harmonized standards:

EN 292-1, EN 292-2
 EN 60335-1
 EN 60335-2-69
 EN 55014-1, EN 55014-2, EN 61000-3-2

Applied national standards and technical specifications:

DIN EN 60335-1
 DIN EN 60335-2-69

Dipl.-Ing. Wolfgang Niewerkamp
 Tests and approvals

Bellenberg, 13.02.2004

Nilfisk ALTO

Why Compromise

<http://www.nilfisk-alto.com>

HEAD QUARTER

DENMARK

Nilfisk-Advance Group
Sognevej 25
DK-2605 Brøndby
Tel.: +45 4323 8100
Fax: +45 4343 7700
E-mail: mail@nilfisk-advance.dk

SALES COMPANIES

AUSTRALIA

Nilfisk-ALTO
48 Egerton St.
P.O. Box 6046
Silverwater, N.S.W. 2128
Tel.: +61 2 8748 5966
Fax: +61 2 8748 5960

AUSTRIA

Nilfisk-Advance GmbH
Nilfisk-ALTO
Metzgerstrasse 68
5101 Bergheim/Salzburg
Tel.: +43 662 456 400-0
Fax: +43 662 456 400-34
E-mail: info@nilfisk-alto.at
www.nilfisk-alto.at

BELGIUM

Nilfisk-ALTO
Division of Nilfisk-Advance n.v.s.a.
Internationalelaan 55 (Gebouw C3/C4)
1070 Brussel
Tel.: +32 02 467 60 40
Fax: +32 02 466 61 50
E-mail: info.be@nilfisk-alto.com

CANADA

Clarke Canada
Part of the Nilfisk-Advance Group
4080 B Sladeview Crescent, Unit 1
Mississauga, Ontario L5L 5Y5
Tel.: +1 905 569 0266
Fax: +1 905 569 8586

CHINA

Nilfisk-Advance (Shenzhen) Ltd.
Blok 3, Unit 130 1001 Honghua Road
Int. Commercial & Trade Center
Fuitan Free Trade Zone
518038 Shenzhen
Tel.: +86 755 8359 7937
Fax: +86 755 8359 1063

CZECH REPUBLIC

ALTO Česká Republika s.r.o.
Zateckých 9
14000 Praha 4
Tel.: +420 24 14 08 419
Fax: +420 24 14 08 439
E-mail: info@alto-cz.com

DENMARK

Nilfisk-ALTO
Division of Nilfisk-Advance A/S
Industrivej 1
9560 Hadsund
Tel.: +45 7218 2100
Fax: +45 7218 2105
E-mail: salg@nilfisk-alto.dk
E-mail: service@nilfisk-alto.dk
www.nilfisk-alto.dk

Nilfisk-ALTO Food division
Division of Nilfisk-Advance A/S
Blytækkervej 2
9000 Aalborg
Tel.: +45 7218 2100
Fax: +45 7218 2099

E-mail: scania.technology@nilfisk-alto.dk

FINLAND

Nilfisk-Advance Oy Ab
Piispantilankuja 4
02240 Espoo
Tel.: +358 207 890 600

Fax: +358 207 890 601
E-mail: jukka.lehtonen@nilfisk-alto.com
www.nilfisk-advance.fi

FRANCE

Nilfisk-ALTO
ALTO France SAS
Aéroparc 1
19 rue Icare
67960 Entzheim
Tel.: +33 3 88 28 84 00
Fax: +33 3 88 30 05 00
E-mail: info@nilfisk-alto.fr
www.nilfisk-alto.com

GERMANY

Nilfisk-ALTO
Division of Nilfisk-Advance AG
Guido-Oberdorfer-Strasse 10
89287 Beilenberg
Tel.: +49 0180 5 37 37 37
Fax: +49 0180 5 37 37 38
E-mail: info@nilfisk-alto.de
www.nilfisk-alto.de

GREECE

Nilfisk-Advance SA
8, Thoudkidou str.
164 52 Argiroupolis
Tel.: +30 210 96 33443
Fax: +30 210 96 52187
E-mail: nilfisk-advance@clean.gr

HOLLAND

Nilfisk-ALTO
Division of Nilfisk-Advance BV
Camerastraat 9
3322 BB Almere
Tel.: +31 36 546 07 60
Fax: +31 36 546 07 61
E-mail: info@nilfisk-alto.nl
www.nilfisk-alto.nl

HONG KONG

Nilfisk-Advance Ltd.
2001 HK Worsteds Mills Ind'l Bldg.
31-39 Wo Tong Tsui St.
Kwai Chung
Tel.: +852 2427 5951
Fax: +852 2487 5828

HUNGARY

Nilfisk-Advance Kereskedelmi Kft.
II. Rákóczi Ferenc út 10
2310 Szigetszentmiklos-Lakihegy
Tel.: +36 2447 5550
Fax: +36 2447 5551
E-mail: info@nilfisk-advance.hu
www.nilfisk-advance.hu

ITALY

Nilfisk-ALTO
Divisione di Nilfisk-Advance A/S
Località Novella Terza
26862 Guardamiglio (LO)
E-mail: d.puglia@nilfisk-advance.it

JAPAN

Nilfisk-Advance Inc.
247 Nippa-cho, Kouhoku-ku
Yokohama, 223-0057
Tel.: +8145 548 2571
Fax: +8145 548 2541

MALAYSIA

Nilfisk-Advance Sdn Bhd
Sri 14, Jalan KIP 11
Taman Perindustrian KIP
Sri Damansara
52200 Kuala Lumpur
Tel.: +60 3 603 6275 3120
Fax: +60 3 603 6274 6318

NORWAY

Nilfisk-Advance AS
Bjørnerudveien 24
1266 Oslo
Tel.: +47 22 75 17 70
Fax: +47 22 75 17 71
E-mail: info@nilfisk-alto.no
www.nilfisk-alto.no

POLAND

Nilfisk-Advance Sp. Z.O.O.
05-800 Pruszków
ul. 3-go MAJA 8
Tel.: +48 22 738 37 50
Fax: +48 22 738 37 51
E-mail: info@nilfisk-alto.pl
www.nilfisk-alto.pl

PORTUGAL

Nilfisk-ALTO
Division of Nilfisk-Advance Lda.
Sintra Business Park
Zona Industrial Da Abrunheira
Edificio 1, 1.º A
P2710-089 Sintra
Tel.: +35 808 200 537
Fax: +35 121 911 2679
E-mail: mkt@nilfisk-advance.es

RUSSIA

Nilfisk-Advance LLC
Vyatskaya str. 27, bld. 7
127015 Moscow
Tel.: +7 495 783 96 02
Fax: +7 495 783 96 03
E-mail: info@nilfisk-advance.ru

SINGAPORE

Nilfisk-Advance Pte. Ltd.
Nilfisk-ALTO Division
40 Loyang Drive
Singapore 508961
Tel.: +65 6 759 9100
Fax: +65 6 759 9133
E-mail: sales@nilfisk-advance.com.sg

SPAIN

Nilfisk-ALTO
Division of Nilfisk-Advance S.A.
Torre D'Ara
Paseo del Rengle, 5 Pl. 10
08302 Mataró
Tel.: +34 902 200 201
Fax: +34 93 757 8020
E-mail: mkt@nilfisk-advance.es

SWEDEN

Nilfisk Sverige AB
Member of Nilfisk-Advance Group
Aminogatan 18, Box 4029
431 04 Mölndal
Tel.: +46 31 706 73 00
Fax: +46 31 706 0011
info@nilfisk-alto.se
www.nilfisk-alto.se

TAIWAN

Nilfisk-Advance Taiwan Branch
No. 5, Wan Fang Road
Taipei
Tel.: +886 227 002 268
Fax: +886 227 840 843

THAILAND

Nilfisk-Advance Co. Ltd.
89 Soi Chokechai-Ruammitr
Viphavadee-Rangsit Road
Layao, Jatuchak, Bangkok 10900
Tel.: +66 2 275 5630
Fax: +66 2 691 4079

TURKEY

Nilfisk-Advance Profesyonel Temizlik
Ekipmanları Tic. A.Ş.
Necla Cad. No: 48
Yenisahra / Kadıköy
İstanbul
Tel.: +90 216 470 08 - 60
Fax: +90 216 470 08 - 63
www.nilfisk-advance.com

UNITED KINGDOM

Nilfisk-ALTO
Division of Nilfisk-Advance Ltd.
Bowerbank Way
Cilwilly Industrial Estate, Penrith
Cumbria CA11 9BQ
Tel.: +44 1 768 86 89 95
Fax: +44 1 768 86 47 13
E-mail: sales@nilfisk-alto.co.uk
www.nilfisk-alto.co.uk

USA

Nilfisk-Advance Inc.
14600 21st Avenue North
Plymouth, MN 55447-3408
Tel.: +1 763 745 3500
Fax: +1 763 745 3718
E-mail: info@nilfisk-advance-us.com
www.advantage-us.com

VIETNAM

Nilfisk-Advance Representative Office
No. 46 Doc Ngu Str.
Ba Dinh Dist.
Hanoi
Tel.: +84 4 761 5642
Fax: +84 4 761 5643
E-mail: nilfisk@vnm.vn